

CONTROL UNITS



Features

- Precise and sophisticated design, user-friendly into application.
- Workable stacking contact block, easy to install and disassembly.
- Smart mounting ring design, can connect $\Phi 22\text{mm}$ switchable to $\Phi 30\text{mm}$ diameter.
- Several push button type options, can completely fulfill your needs.
- Several emergency stop of push button options.
- Several positional removable options.
- Several control box options.
- Compliance to UL approval.



Specifications

Standards	EN60947-5-1, UL508
Approvals	UL, and CE marked
Utilization Category	AC15 A600
Min Current	5V, 5mA, DC
Thermal Current (Ith)	10A
Rated Insulation Voltage	600V AC
Rated Impulse withstand Volt	2500V AC
Insulation Resistance	100M Ω min. (DC 500V)
Contact Resistance	50m Ω max. (Initial)
Shock Resistance	500 m/s ²
Max Switching Frequency	1800 operation per hour
Operating Temperature	Min -5°C (+23°F) Max 40°C (+104°F)
Mech. Life Expectancy	1 x 10 ⁷ Cycle min
Electrically Life Expectancy	100,000 Cycle min
Vibration	IEC 68-2-6, 10-55Hz \pm 1 Hz, Excursion: 0.35mm, 1 octave/min
Screw Torque	0.8N-m for five seconds without any fracture
Tightening Torque	2.5N-m for one min. without any fracture

HIGHLY

G1

Design, specifications are subject to change without notice.

CONTROL UNITS

PUSH BUTTON SWITCH

Structure Description

Mounting Holder

Mounting adapters available to make $\phi 22\text{mm}$ compatible to $\phi 30\text{mm}$ Mounting diameter.

Mounting Ring

Smart mounting ring can carry with various push button type

Contact Block

Slow-action: 1NC, 1NO.
Easy stackable contact block.
Compatible With LED holder.
Easy handling design.

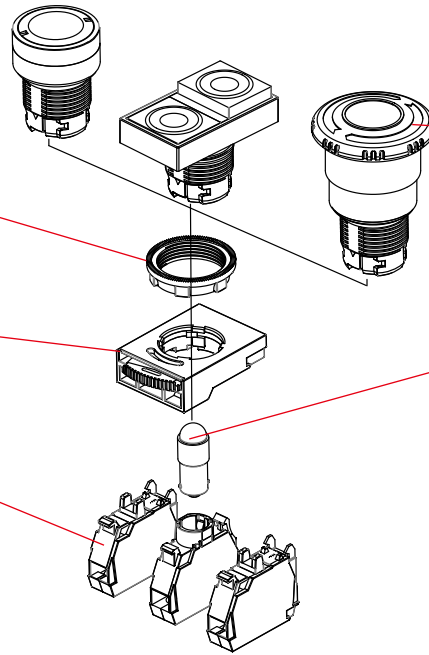

Push Button

Several Emergency stop options
Non-LED or LED options
Several cap color options
Alternate/Alternate with click/ Momentary
/Pull and lock/Push-in lock/Key button options

S-9 LED LAMP

Several LED color options
Several bulb voltage options
AC.DC 24V
AC.DC 110-120V
AC.DC 220-240V
AC 380-440V
AC.DC 12V

Product Selection

H□B22-□ □ □ □ □

1 2 3 4 5 6

1. SERIES

HPB22 Non-illuminated

HLB22 LED illuminated

3. CONTACT BLOCKS

10 1NO 21 2NO/1NC

01 1NC 12 1NO/2NC

11 1NO/1NC 22 2NO/2NC

21 2NO/1NC 02 2NC

4. CAP COLOR

R RED

G GREEN

Y YELLOW

S BLUE

B BLACK

W WHITE

5. LED BULB VOLTAGE

A AC.DC 24V

E AC.DC 110-120V

I AC.DC 220-240V

M AC 380-440V

Y AC.DC 12V

2. HEAD TYPE

HPB22 HLB22

Head Type	HPB22	HLB22
D Double Push Button	√	√
E Elevation Head	√	√
F Flush Head	√	√
G Mushroom Head Push-Push to release (40φ)	√	√
H Flush Head Rest Push-Pull Stop(40φ)	√	-
I Turn To Reset Mushroom Head (40φ)	√	-
J Turn To Reset Mushroom Head (40φ)	√	-
K Mushroom Head (40φ) With Key	√	-
L Flush Head Push-Push to release	√	√
M Mushroom Head (40φ)	√	√
P Projecting Head Push-push to release	√	√
R Turn To Reset Head (40φ)	√	√
S Reset Push-Pull Stop Mushroom Head (35φ)	√	-
T Turn To Reset Head (40φ)	√	√

HIGHLY

G2

Design, specifications are subject to change without notice.

CONTROL UNITS

Operating Characteristics

Unit: mm

Item Description Dimensions

HPB22-F / HPB22-L



HEAD TYPE	ITEM	CAP COLOR
HPB22-F: Flush Head	HPB22-F□R	RED
	HPB22-F□G	GREEN
	HPB22-F□Y	YELLOW
HLB22-L: Flush Head With Lock	HPB22-F□S	BLUE
	HPB22-F□B	BLACK
	HPB22-F□W	WHITE

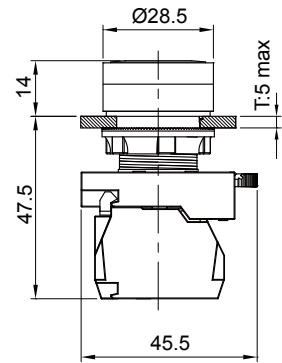

HPB22-E / HPB22-P



HEAD TYPE	ITEM	CAP COLOR
HPB22-E: Elevation Head	HPB22-E□R	RED
	HPB22-E□G	GREEN
	HPB22-E□Y	YELLOW
HLB22-P: Elevation Head With Lock	HPB22-E□S	BLUE
	HPB22-E□B	BLACK
	HPB22-E□W	WHITE

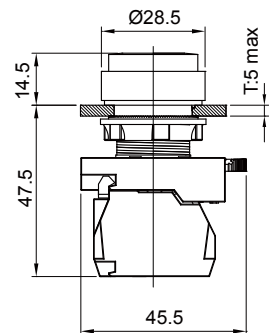

HLB22-F / HLB22-L



HEAD TYPE	ITEM	CAP COLOR
LED illuminated	HLB22-F□R	RED
HLB22-F: Flush Head	HLB22-F□G	GREEN
	HLB22-F□Y	YELLOW
HLB22-L: Flush Head With Lock	HLB22-F□S	BLUE
	HLB22-F□W	WHITE

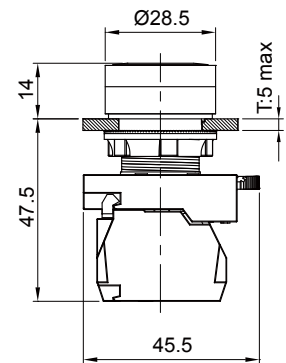

HLB22-E / HLB22-P



HEAD TYPE	ITEM	CAP COLOR
LED illuminated	HLB22-E□R	RED
HLB22-E: Elevation Head	HLB22-E□G	GREEN
	HLB22-E□Y	YELLOW
HLB22-P: Elevation Head With Lock	HLB22-E□S	BLUE
	HLB22-E□W	WHITE

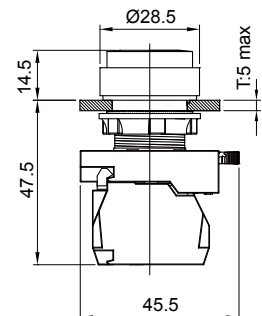

HIGHLY

G3

Design, specifications are subject to change without notice.

CONTROL UNITS

Operating Characteristics

Unit: mm

Item Description Dimensions

HPB22-D



HEAD TYPE	ITEM
HPB22-D: Double Push Button	HLB22-D□

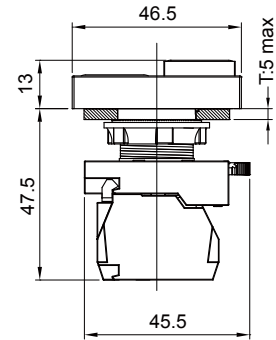

HLB22-D



HEAD TYPE	ITEM	LED COLOR
LED illuminated	HLB22-D□R	RED
HLB22-D: Double Push Button	HLB22-D□G	GREEN
	HLB22-D□Y	YELLOW

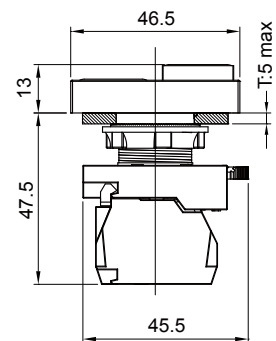

HPB22-M/HPB22-G



HEAD TYPE	ITEM	CAP COLOR
HPB22-M: Mushroom Head (40φ)	HPB22-M□R	RED
HPPB22-G: Mushroom Head (40φ) With Lock	HPB22-M□G	GREEN
	HPB22-M□Y	YELLOW

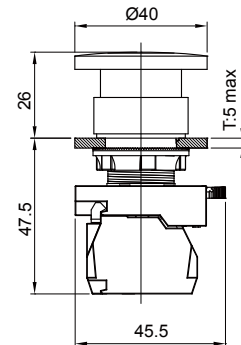

HLB22-M/HLB22-G



HEAD TYPE	ITEM	LED COLOR
LED illuminated	HLB22-M□R	RED
HLB22-M: Mushroom Head (40φ)	HLB22-M□G	GREEN
	HLB22-M□Y	YELLOW

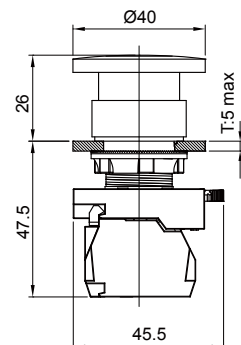

HIGHLY

G4

Design, specifications are subject to change without notice.

CONTROL UNITS

Operating Characteristics

Unit: mm

Item Description Dimensions

HPB22-T / HLB22-T



HEAD TYPE	ITEM	LED COLOR
HPB22-T: Turn To Reset Head (40φ)	HPB22-T□	---
HLB22-T: LED illuminated	HLB22-T□R	RED

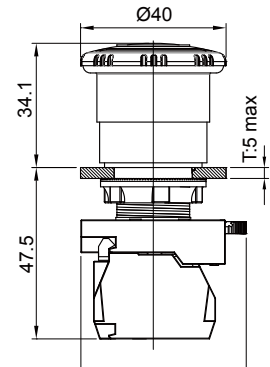

HPB22-R/HLB22-R



HEAD TYPE	ITEM	LED COLOR
HPB22-R: Turn To Reset Head (40φ)	HPB22-R□	---
HLB22-R: LED illuminated	HLB22-R□R	RED

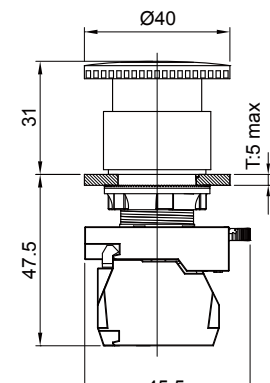

HPB22-J



HEAD TYPE	ITEM	CAP COLOR
HPB22-J: Turn To Reset Mushroom Head (40φ)	HPB22-J□	RED

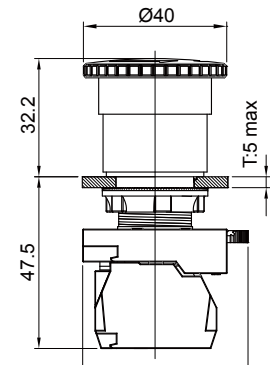

HPB22-H



HEAD TYPE	ITEM	CAP COLOR
HPB22-H: Turn To Reset Mushroom Head (40φ)	HPB22-H□	RED

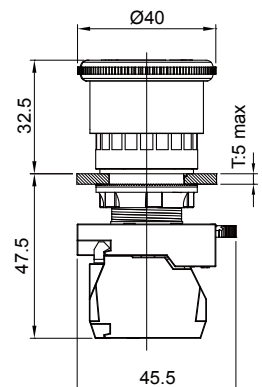

HIGHLY

G5

Design, specifications are subject to change without notice.

CONTROL UNITS

Operating Characteristics

Unit: mm

Item Description Dimensions

HPB22-K



HEAD TYPE	ITEM	CAP COLOR
HPB22-K: Mushroom Head (40φ) With Key	HPB22-K□	RED

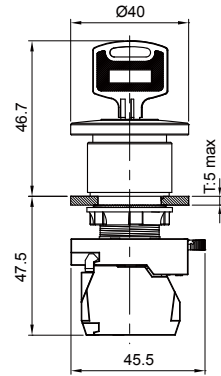

HPB22-I



HEAD TYPE	ITEM	CAP COLOR
HPB22-I: Turn To Reset Mushroom Head (40φ)	HPB22-I□	RED

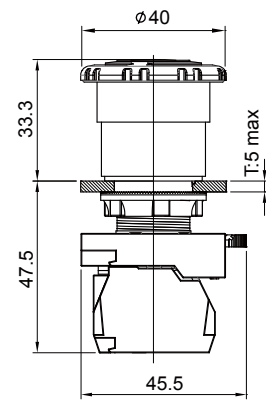

HPB22-S



HEAD TYPE	ITEM	CAP COLOR
HPB22-S: Reset Push-Pull Stop Mushroom Head (35φ)	HPB22-S□	RED

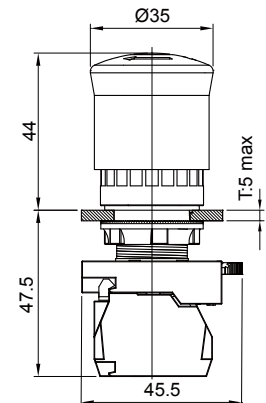

HIGHLY

G6

Design, specifications are subject to change without notice.