

# D COMPACT ENCLOSED SWITCH

## Features

- High precision and long life.
- Suitable for applications demanding higher mechanical strength,
- Gasket diaphragm seal provides high environmental resistance.



## Specifications

Item	Standard
Rating	10A, 125V or 250VAC
Contact Resistance	25mΩ max. (initial)
Insulation Resistance	100MΩ min. (at 500VDC)
Dielectric Strength	1,000VAC,50/60Hz for 1 minute
Service Life Mechanically:	1,000,000 operations min.
Service Life Electrically	100,000 operations min.

## Product Selection

D

1

### 1. HEAD AND ACTUATOR

- 5000:** Push plunger type
- 5020:** Roller plunger type
- 5040:** Cross Roller plunger type
- 1000:** Lever type
- 1020:** Short Lever type
- 2000:** Lever roller type
- 2020:** Short Lever roller type

## Mounting Hole

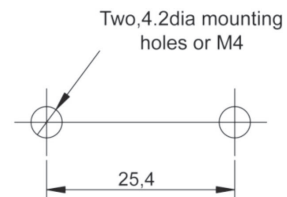

## Contact Configuration

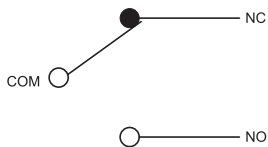

**HIGHLY**

C9

Design, specifications are subject to change without notice.



# D COMPACT ENCLOSED SWITCH

## Operating Characteristics

Unit: mm

Item

Operating Characteristics

Dimensions

D2000

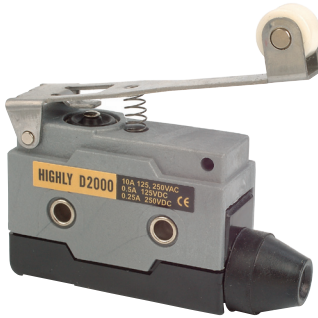

OF max.	195g
RF min.	28g
PT max.	8.5 mm
OT min.	3.2 mm
MD max.	2.6 mm
OP	40 ± 1 mm
FP	50 mm

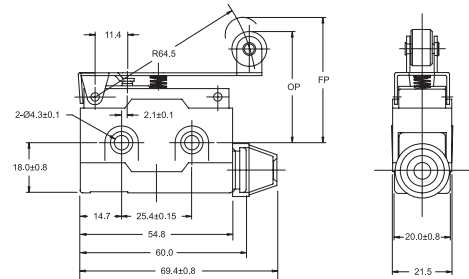

D2020



OF max.	300g
RF min.	40g
PT max.	6 mm
OT min.	2 mm
MD max.	1.5 mm
OP	40 ± 1 mm
FP	46 mm

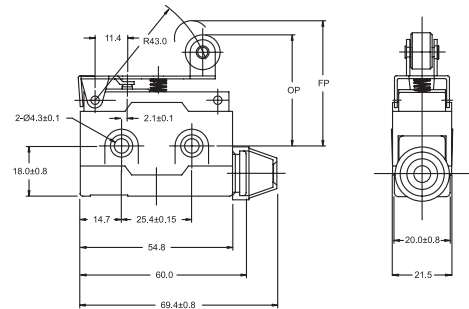

D1000



OF max.	170g
RF min.	25g
PT max.	10 mm
OT min.	4 mm
MD max.	3 mm
OP	25 ± 1 mm
FP	35 mm

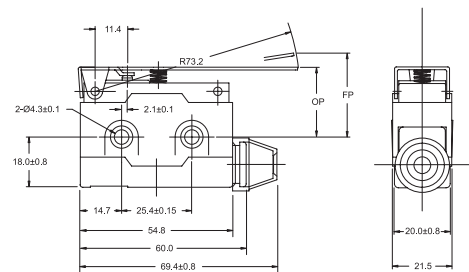

**HIGHLY**

C11

Design, specifications are subject to change without notice.

# D COMPACT ENCLOSED SWITCH

## Operating Characteristics

Unit: mm

Item Operating Characteristics Dimensions

D1020



OF max. 260g

RF min. 35g

PT max. 7 mm

OT min. 2.5 mm

MD max. 1.7 mm

OP 25 ± 1 mm

FP 32 mm

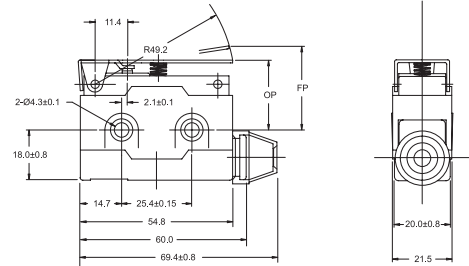

NOTE:

**HIGHLY**

C12

Design, specifications are subject to change without notice.